

# JVC

VIDEO CASSETTE RECORDER

# HR-J695EA

# HR-J291EA



## INSTRUCTIONS

LPT0724-001B  
COPYRIGHT © 2002 VICTOR COMPANY OF JAPAN, LTD.

Printed in Indonesia  
0702 MNV\*ID\*OT

<b>SAFETY FIRST</b> .....	<b>1</b>
<b>Buttons, Connectors and Indicators</b> .....	<b>3</b>
Front Panel .....	3
Rear Panel .....	3
Remote control .....	3
On-screen display .....	4
Main Menu .....	4
<b>Basic Connections</b> .....	<b>5</b>
<b>Initial Settings</b> .....	<b>6</b>
Video Channel Set .....	6
Language Set .....	6
Clock Set .....	7
Tuner Set .....	7
<b>Playback</b> .....	<b>10</b>
<b>Recording</b> .....	<b>11</b>
<b>Timer Recording</b> .....	<b>12</b>
Timer Programming .....	12
Checking, canceling or changing programme settings .....	13
<b>Editing</b> .....	<b>14</b>
Editing with another video recorder or a camcorder .....	14
<b>System Connections</b> .....	<b>15</b>
Connecting/Using a stereo system (HR-J695EA only) .....	15
<b>Subsidiary Settings</b> .....	<b>15</b>
Recorder's Information (Self-Diagnosis) .....	15
Colour System Set .....	15
Child Lock .....	15
<b>Specifications</b> .....	<b>16</b>

### SAFETY FIRST

#### Safety Precautions

The rating plate and the safety caution are on the rear of the unit.  
**WARNING: DANGEROUS VOLTAGE INSIDE**  
**WARNING: TO PREVENT FIRE OR SHOCK HAZARD, DO NOT EXPOSE THIS UNIT TO RAIN OR MOISTURE.**

#### CAUTION

- When you are not using the recorder for a long period of time, it is recommended that you disconnect the power cord from the mains outlet.
- Dangerous voltage inside. Refer internal servicing to qualified service personnel. To prevent electric shock or fire hazard, remove the power cord from the mains outlet prior to connecting or disconnecting any signal lead or aerial.

#### ATTENTION

1. This recorder can also receive SECAM colour television signals for recording and playback.
2. Recordings made of SECAM television signals produce monochrome pictures if played back on another video recorder of SECAM standard, or do not produce normal colour pictures if played back on another video recorder of PAL standard.
3. SECAM prerecorded cassettes or recordings made with a SECAM video recorder produce monochrome pictures when played back with this recorder.

#### POWER SYSTEM

This set operates on voltage of AC 110 V – 240 V~ (Rating), AC 90 V – 260 V~ (Operating), 50 Hz/60 Hz with automatic switching.

#### IMPORTANT

- Please read the various precautions on page 1 and 2 before installing or operating the recorder.
- It should be noted that it may be unlawful to re-record pre-recorded tapes, records, or discs without the consent of the owner of copyright in the sound or video recording, broadcast or cable programme and in any literary, dramatic, musical, or artistic work embodied therein.

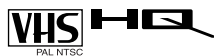

- Cassettes marked "VHS" (or "S-VHS") can be used with this video cassette recorder, however, only VHS signals can be played back and recorded.
- HQ VHS is compatible with existing VHS equipment.

The STANDBY/ON  $\phi$ /I button does not completely shut off mains power from the unit, but switches operating current on and off. “ $\phi$ ” shows electrical power standby and “I” shows ON.

Video tapes recorded with this video recorder in the LP (Long Play) mode cannot be played back on a single-speed video recorder.

When the equipment is installed in a cabinet or a shelf, make sure that it has sufficient space on all sides to allow for ventilation (10 cm or more on both sides, on top and at the rear).

When discarding batteries, environmental problems must be considered and the local rules or laws governing the disposal of these batteries must be followed strictly.

**Failure to heed the following precautions may result in damage to the recorder, remote control or video cassette.**

1. **DO NOT** place the recorder ...
  - ... in an environment prone to extreme temperatures or humidity.
  - ... in direct sunlight.
  - ... in a dusty environment.
  - ... in an environment where strong magnetic fields are generated.
  - ... on a surface that is unstable or subject to vibration.
2. **DO NOT** block the recorder's ventilation openings or holes. (If the ventilation openings or holes are blocked by a newspaper or cloth, etc., the heat may not be able to get out.)
3. **DO NOT** place heavy objects on the recorder or remote control.
4. **DO NOT** place anything which might spill on top of the recorder or remote control. (If water or liquid is allowed to enter this equipment, fire or electric shock may be caused.)
5. **DO NOT** expose the apparatus to dripping or splashing.
6. **DO NOT** use this equipment in a bathroom or places with water. Also **DO NOT** place any containers filled with water or liquids (such as cosmetics or medicines, flower vases, potted plants, cups, etc.) on top of this unit.
7. **DO NOT** place any naked flame sources, such as lighted candles, on the apparatus.
8. **AVOID** violent shocks to the recorder during transport.

## MOISTURE CONDENSATION

Moisture in the air will condense on the recorder when you move it from a cold place to a warm place, or under extremely humid conditions—just as water droplets form on the surface of a glass filled with cold liquid. Moisture condensation on the head drum will cause damage to the tape. In conditions where condensation may occur, keep the recorder's power turned on for a few hours to let the moisture dry.

## How to use the remote control

Before use, insert the batteries in the correct directions as indicated under the battery cover. The remote control can operate most of your recorder's functions, as well as basic functions of JVC TV sets.

- Point the remote control toward the receiving window on the recorder.
- The maximum operating distance of the remote control is about 7.5 m.
- To operate your JVC TV, press the corresponding button: **TV  $\phi$ /I**, **TV AV**, **TV PR +/-**, **TV  $\triangle$ +/-** (TV Volume).

### NOTE:

*If the remote control does not work properly, remove its batteries, wait for a few seconds, replace the batteries and then try again.*

## Video heads cleaning

Accumulation of dirt and other particles on the video heads may cause the playback picture to become blurred or interrupted. Be sure to contact your nearest JVC dealer if such troubles occur.

## Usable cassettes

- Compact VHS camcorder recordings can be played on this recorder. Simply place the recorded cassette into a VHS Cassette Adapter and it can be used just like any full-sized VHS cassette.
- This recorder can record on regular VHS and Super VHS cassettes. However, it will record and play back regular VHS signals only. It is not possible to play back a recorded Super VHS cassette.



### ATTENTION:

#### To mobile phone users:

Using a mobile phone in the vicinity of the recorder may cause picture vibration on the TV screen or change the screen to a blue back display.

#### On placing the recorder:

Some TVs or other appliances generates strong magnetic fields. Do not place such appliance on top of the recorder as it may cause picture disturbance.

# Buttons, Connectors and Indicators

## Front Panel

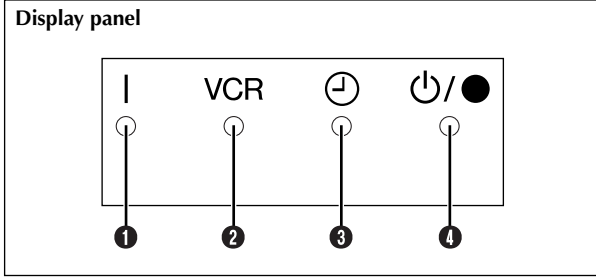
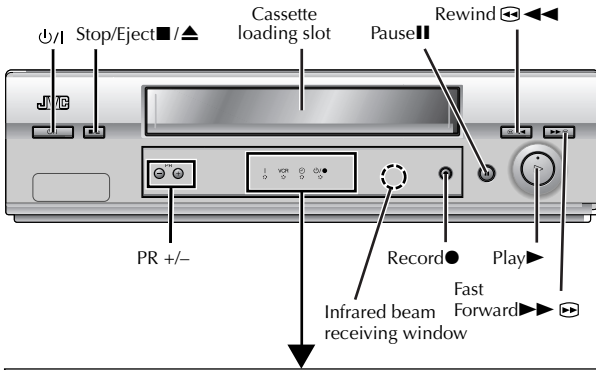

- 1 Power Indicator
- 2 VCR Indicator
- 3 Timer Indicator
- 4 Standby/Record Indicator\*

\* Standby/Record Indicator lights when the recorder is in standby mode or during recording.

## Rear Panel

### HR-J695EA

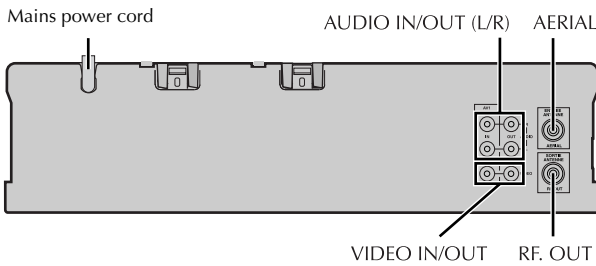

### HR-J291EA

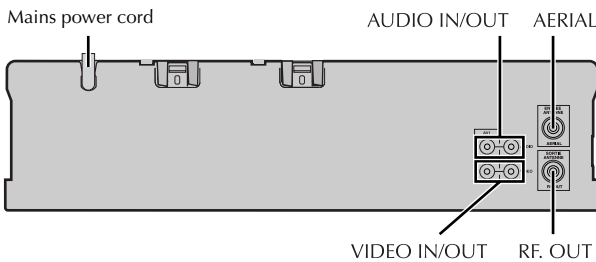

## Remote control

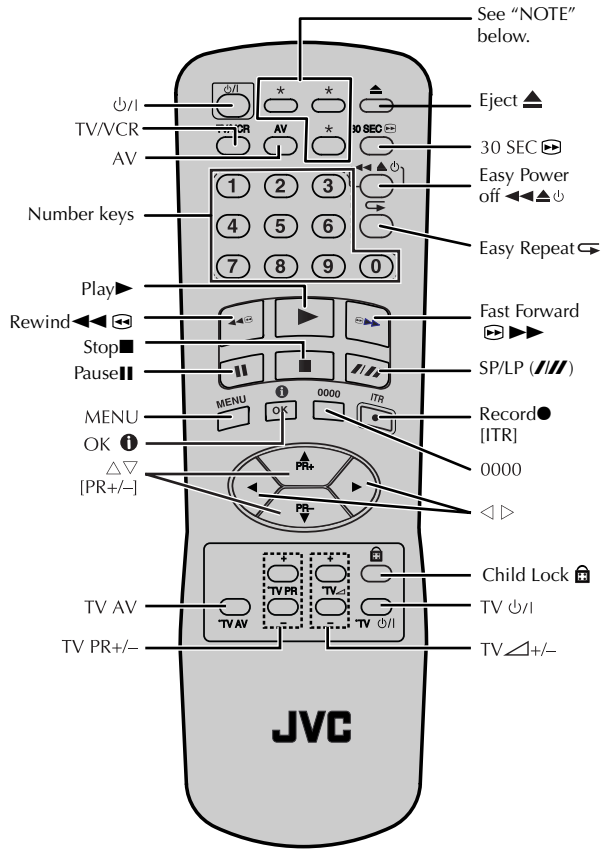

See "NOTE" below.

### NOTE:

The buttons with \* do not function with this recorder.

## On-screen display

If you press **1** (OK) on the remote control, you can see the current recorder status on the screen. The indications except the clock or time counter disappears in about 5 seconds. To clear the on-screen display completely, press **1** (OK) again. The indications are not recorded even if the recorder is in the recording mode.

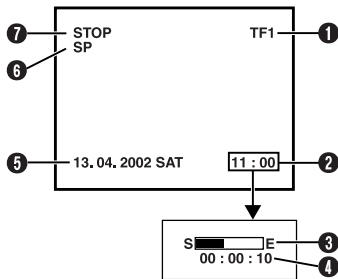

- 1** Channel and auxiliary input
- 2** Clock\*
- 3** Tape position\*
- 4** Time counter\*
- 5** Current day/month/year
- 6** Tape speed
- 7** Recorder operation mode

On-screen display	Description
PLAY	appears when you playback.
REW	appears during rewinding, or blinks during rewinding with Rewind Power Off function. (ⓘ 10)
FF	appears during fast-forwarding.
EZ REPEAT	appears during Ez repeat playback. (ⓘ 10)
EJECT	appears when you eject the cassette.
STOP	appears when you stop playback or recording.
REC	appears during recording.
REC PAUSE	appears in the record pause mode.
SAFE	appears when the recorder enters in child lock mode, or any buttons on the recorder are pressed during child lock mode. (ⓘ 15)

\* Each time you press **1** (OK), the display shows clock or tape position and time counter alternatively.

## Main Menu

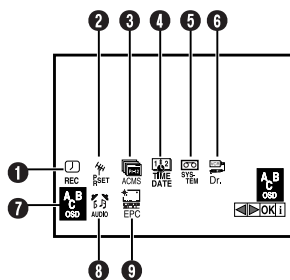

You can perform various operations or change various mode settings on the Main Menu Screen.

- Turn on the recorder and the TV, and set your TV to its AV mode or video channel.
- The procedure shows how to set "ABC OSD" to "ENGLISH".

### 1 Access Main Menu screen

Press **MENU**. Press **<** **>** to select the icon "ABC OSD", then press **OK**.

- If you select the icon **1** to **4**, follow the each setting procedure.
- If you select the icon **5** to **9**, go to step **2**.

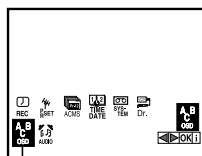

ABC OSD

### 2 Change setting







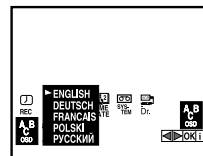

Press **△▽** to set to "ENGLISH", then press **<** or **>**.

### 3 Return to normal screen

Press **MENU**.



\*The default setting is **bold** in the following table.

Icon	Description
<b>1</b> REC  REC	Select this icon to timer-record the programme. (ⓘ 12)
<b>2</b> PR SET  PR SET	Select this icon to perform Manual Channel Set. (ⓘ 8, 9)
<b>3</b> ACMS  ACMS	Select this icon to perform Auto Channel Set. (ⓘ 7) Auto Channel Set automatically assigns all receivable stations in your area.
<b>4</b> TIME DATE  TIME DATE	Select this icon to set clock manually. (ⓘ 7)
<b>5</b> SYSTEM  SYS-TEM	<b>AUTO / PAL / MESECAM / NTSC PB / NTSC3.58 / NTSC4.43</b> Select the appropriate colour system when you play back or recording a tape. For details, refer to "Colour System Set" (ⓘ 15).
<b>6</b> VCR Dr.  Dr.	This function allows you to check the status of the recorder and tape inserted into the recorder, and the detailed information of the timer programme setting. For details, refer to "Recorder's Information (Self-Diagnosis)" (ⓘ 15).
<b>7</b> ABC OSD  A B C OSD	Select this icon to set the language. You can select among 5 languages. (ⓘ 6)
<b>8</b> AUDIO  AUDIO	<b>STEREO / LEFT / RIGHT / MONO</b> (HR-J695EA only) Your recorder is capable of recording four soundtracks (STEREO, LEFT, RIGHT and MONO) and plays back the one you select. <b>STEREO</b> : For Hi-Fi stereo tapes <b>LEFT</b> : For main audio of Bilingual tapes <b>RIGHT</b> : For sub audio of Bilingual tapes <b>MONO</b> : For audio-dubbed tapes
<b>9</b> EPC  EPC	<b>OFF / SOFT / SHARP</b> This function helps you to adjust the playback picture quality according to your preference. <b>OFF</b> : Picture quality is not adjusted. <b>SOFT</b> : Reduces image coarseness when viewing overplayed tapes containing much noise. <b>SHARP</b> : Clearer, sharper-edged picture when viewing images with much flat, same-coloured surfaces such as cartoons. <b>NOTE:</b> You can perform EPC setting only during playback.

## Basic Connections

### 1 Check contents

Make sure the package contains all of the accessories listed in "Specifications" (p. 16).

### 2 Situate recorder

Place the recorder on a stable, horizontal surface.

### 3 Connect recorder to TV

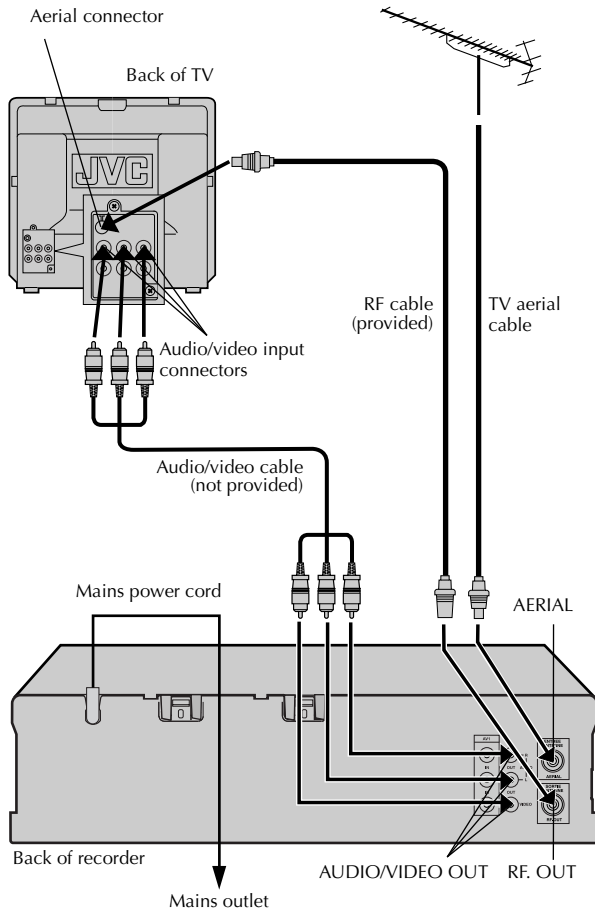

## RF Connection

- 1 Disconnect the TV aerial cable from the TV.
- 2 Connect the TV aerial cable to the AERIAL connector on the rear of the recorder.
- 3 Connect the provided RF cable between the RF. OUT connector on the rear of the recorder and the TV's aerial connector.

## AV Connection

If your TV is equipped with audio/video input connectors, perform AV connection to improve picture quality during tape playback.

- 1 Connect the aerial, recorder and TV as shown in the illustration.
- 2 Connect an optional audio/video cable between the AUDIO/VIDEO OUT connectors on the rear of the recorder and the TV's audio/video input connectors.

### NOTE:

**For HR-J291EA owners:**

If your TV has audio L and R input connectors, connect the recorder's AUDIO OUT connector to the TV's audio L input connector.

## Initial Settings

### Video Channel Set

Video channel (RF output channel) is the channel on which your TV receives picture and sound signals from the recorder through the RF cable.

**If you have connected the recorder to your TV via the RF connection, set the correct video channel.**

Turn on the recorder and TV.

#### 1 Set the channel on TV

Select the vacant position 36 on your TV.

#### 2 Access Video Channel Set mode

Press  $\psi/1$  on the remote control to enter the standby mode. Press and hold **PR+** or **-** on the recorder for more than 4 seconds.

- If the two vertical white bars appear clearly on the screen on the right, the position 36 is your video channel.
- If the two vertical white bars do not appear clearly, go to step 3.

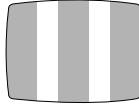

#### 3 Set video channel

Select a vacant position between 22 and 68 on your TV. Press **PR +** or **-** on the recorder until the two vertical white bars appear clearly on the screen

#### With AV connection

To view picture signals from the recorder, set your TV to its AV mode.

#### With RF connection

To view picture signals from the recorder, set your TV to the video channel.

## Language Set

You can change the language setting manually as required.

Turn on the recorder and the TV, and set your TV to its AV mode or video channel.

#### 1 Access Main Menu screen

Press **MENU**. Press  $\triangleleft$   $\triangleright$  to select the icon "ABC OSD", then press **OK**.

#### 2 Select language

Press  $\triangle$   $\nabla$  to select the desired language.

ENGLISH : English  
DEUTSCH : German  
FRANCAIS : French  
POLSKI : Polish  
РУССКИЙ : Russian

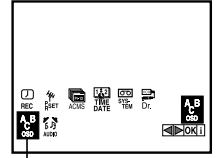

ABC OSD

#### 3 Return to normal screen

Press **MENU**.

## Clock Set

Turn on the recorder and the TV, and set your TV to its AV mode or video channel.

### 1 Access Main Menu screen, then Clock Set screen

Press **MENU**. Press  $\triangleleft$   $\triangleright$  to select the icon "TIME DATE", then press **OK**.

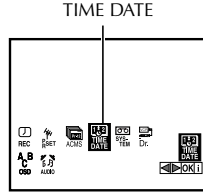

### 2 Set time, date and year

Press  $\triangle$   $\nabla$  until the desired setting appears, then press  $\triangleright$ .

**OR**

Press the appropriate **number keys** for each setting.

- Input "0" before any single number entries.

### 3 Start clock

Press **MENU**.

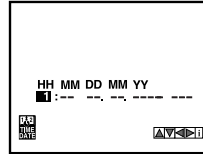

HH: Hour  
MM: Minute  
DD: Day  
MM: Month  
YY: Year

## Tuner Set

The recorder needs to memorise all necessary stations in channel positions in order to record TV programmes. Auto Channel Set automatically assigns all receivable stations in your area.

Turn on the recorder and the TV, and set your TV to its AV mode or video channel.

### Auto Channel Set

#### 1 Access Main Menu screen, then Auto Channel Set screen

Press **MENU**. Press  $\triangleleft$   $\triangleright$  to select the icon "ACMS", then press **OK**.

#### 2 Perform Auto Channel Set

Press **OK**.

- When Auto Channel Set is completed, the Confirmation screen appears.

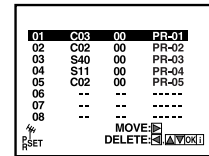
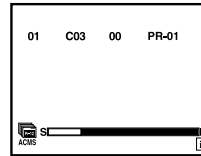
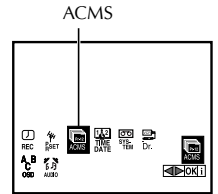

#### 3 Return to normal screen

Press **MENU**.

#### NOTES:

- Depending on reception conditions, the stations may not be stored in order, and the station names may not be stored correctly.
- To delete stations with poor reception condition, refer to "Deleting a channel" (p. 8).

## Manual Channel Set

Store channels that were not stored during Auto Channel Set.

### 1 Access Main Menu screen, then Manual Channel Set screen

Press **MENU**. Press  $\triangleleft \triangleright$  to select the icon "PR SET", then press **OK**.

- The Manual Channel Set screen of the channel position currently received appears.

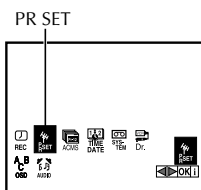

### 2 Access Confirmation screen

Press **MENU**.

### 3 Select position

Press  $\triangle \nabla$  to select the open channel position, then press **OK**.

### 4 Select band

Press **AV** to select C (regular) or S (cable).

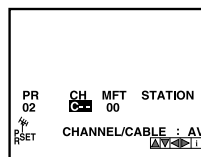

### 5 Input channel

Press the **number keys** or  $\triangle \nabla$  to input the channel number you want to store. Input "0" before any single number entries.

- For fine tuning adjustment, press  $\triangleright$  to select "MFT" setting, then press  $\triangle \nabla$  to perform fine tuning.
- To input the registered station name, press  $\triangleright$  to select "STATION" setting, then press **OK**. Press  $\triangle \nabla$  until the desired station name appears.

### 6 Store new channel

Press **MENU**. The Confirmation screen appears.

- Repeat steps 3 – 6 as necessary.

### 7 Return to normal screen

Press **MENU**.

## Deleting a channel

### 1 Access Main Menu screen, then Manual Channel Set screen

Press **MENU**. Press  $\triangleleft \triangleright$  to select the icon "PR SET", then press **OK**.

- The Manual Channel Set screen of the channel position currently received appears.

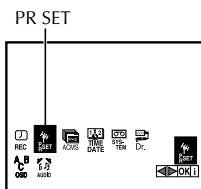

### 2 Access Confirmation screen

Press **MENU**.

### 3 Select position

Press  $\triangle \nabla$  to select the channel you want to delete.

### 4 Delete channel

Press  $\triangleleft$ . The channel directly beneath the cancelled one moves up one line.

- Repeat steps 3 – 4 as necessary.

### 5 Return to normal screen

Press **MENU**.

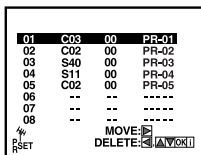

## Changing station channel positions

### 1 Access Main Menu screen, then Manual Channel Set screen

Press **MENU**. Press  $\triangleleft \triangleright$  to select the icon "PR SET", then press **OK**.

- The Manual Channel Set screen of the channel position currently received appears.

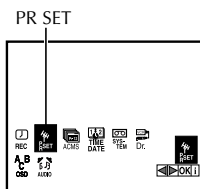

### 2 Access Confirmation screen

Press **MENU**.

### 3 Select position

Press  $\triangle \nabla$  to select the station you want to move, then press  $\triangleright$ .

### 4 Select new position

Press  $\triangle \nabla$  to move the station to the new position, then press **OK**.

**Example:** If you moved the station in position 4 to position 2, the stations originally in positions 2 and 3 each move down one space.

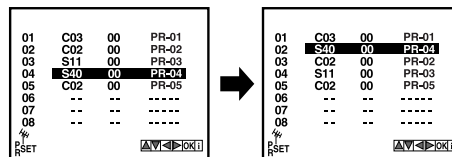

- Repeat steps 3 – 4 as necessary.

### 5 Return to normal screen

Press **MENU**.

## Changing station name (A)

### 1 Access Main Menu screen, then Manual Channel Set screen

Press **MENU**. Press  $\triangleleft \triangleright$  to select the icon "PR SET", then press **OK**.

- The Manual Channel Set screen of the channel position currently received appears.

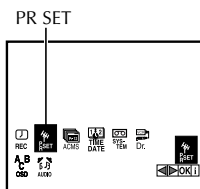

### 2 Access Confirmation screen

Press **MENU**.

### 3 Select position

Press  $\triangle \nabla$  to select the channel, then press **OK**.

### 4 Select station name

Press  $\triangleright$  to select "STATION" setting, then press **OK**. Press  $\triangle \nabla$  until the desired station name appears, then press **OK**.

### 5 Check setting

Press **MENU**. The Confirmation screen appears.

- Repeat steps 3 – 5 as necessary.

### 6 Return to normal screen

Press **MENU**.



## Changing station name (B)

### 1 Access Main Menu screen, then Manual Channel Set screen

Press **MENU**. Press  $\triangleleft \triangleright$  to select the icon "PR SET", then press **OK**.

- The Manual Channel Set screen of the channel position currently received appears.

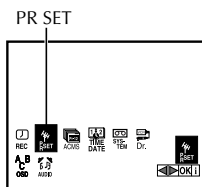

### 2 Access Confirmation screen

Press **MENU**.

### 3 Select position

Press  $\triangle \nabla$  to select the channel, then press **OK**.

### 4 Select character for station name

Press  $\triangleright$  to select "STATION" setting, then press **OK**. Press  $\triangleright$  until the first letter of the station name begins blinking.

### 5 Enter new character

Press  $\triangle \nabla$  to cycle through the characters, then press  $\triangleright$ . Enter the remaining characters the same way (maximum of 5). After entering all characters, press **OK**.

- The characters available for the station name are A–Z, 0–9, +, –, . (period), \_ (space).
- If you make a mistake, press  $\triangleleft$  until the incorrect character begins blinking. Then enter the correct character by pressing  $\triangle \nabla$ .

### 6 Check setting

Press **MENU**. The Confirmation screen appears.

### 7 Return to normal screen

Press **MENU**.

## Fine-tuning channels

### 1 Access Main Menu screen, then Manual Channel Set screen

Press **MENU**. Press  $\triangleleft \triangleright$  to select the icon "PR SET", then press **OK**.

- The Manual Channel Set screen of the channel position currently received appears.

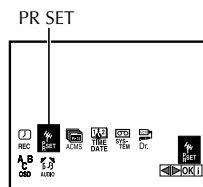

### 2 Access Confirmation screen

Press **MENU**.

### 3 Select position

Press  $\triangle \nabla$  to select the channel you want to tune, then press **OK**.

### 4 Perform tuning

Press  $\triangleleft \triangleright$  to select "MFT" setting, then press  $\triangle \nabla$  until the picture is its clearest.

- Repeat steps 3 – 4 as necessary.

### 5 Return to normal screen

Press **MENU** twice.

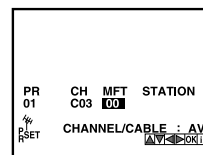

# Playback

## Basic Playback

Turn on the TV and select the AV mode or video channel.

### 1 Load a cassette

Make sure the window side is up, the rear label side is facing you and the arrow on the front of the cassette is pointing towards the recorder.



- Do not apply too much pressure when inserting.
- The recorder turns on, and the counter is reset, automatically.
- If the cassette's record safety tab has been removed, playback begins automatically.

### 2 Start playback

Press ►.

- If the tape reaches its end during playback, the recorder stops playback, rewinds the tape and ejects the cassette, then enters the standby mode automatically.

## During playback

### Stop playback

Press ■ on the remote OR Press ■/▲ on the recorder control.

### Pause playback and view still picture

Press II.

- The recorder enters Pause mode after moving 2 or 3 frames.
- If there is vertical jitter, use the PR+/- to correct the picture.
- Press ► to resume normal playback.
- Still picture playback stops automatically after about 5 minutes to protect the heads, then normal playback resumes.

### Pause and Frame-by-Frame playback (HR-J695EA only)

Press II to pause, then press II repeatedly.

- Press ► to resume normal playback.

### Slow-motion (HR-J695EA only)

During still picture, press ▷ to start forward slow motion playback. If you press II, still picture resumes.

- Press ► to resume normal playback.
- Slow motion playback stops automatically after about 30 seconds to protect the heads, then normal playback resumes.

### High-Speed Search

Press ◀◀ or ▶▶.

- Press ► to resume normal playback.
- High-speed search stops automatically after about 3 minutes to protect the heads, then normal playback resumes.

### Variable Speed Search (HR-J695EA only)

Press ◀ or ▶ repeatedly.

- Press ► to resume normal playback.
- Each time you press ◀ or ▶, the playback speed changes. To decrease the speed during picture search, press the opposite direction button repeatedly.
- If there is vertical jitter, use the PR+/- to correct the picture.

### ATTENTION:

In the search, still or slow-motion\* or frame-by-frame\* playback mode,

- the picture will be distorted
- the noise bars will appear
- there will be a loss of color with an LP-recorded tape.

\* HR-J695EA only

## Variable Speed Search (HR-J695EA only)

Reverse search 2 steps	Reverse play	Still	Forward slow motion 1 step	Normal play	Forward search 2 steps
------------------------	--------------	-------	----------------------------	-------------	------------------------

## When the tape is not running

### Rewind/fast-forward at high speed

Press ◀◀ or ▶▶.

- If you press and hold ◀◀ or ▶▶ during rewinding or fast-forwarding, you can see the picture on the screen. Releasing it cancels the picture search and resume rewinding and fast-forwarding.

### Eject the cassette

Press ▲.

OR Press ■/▲ on the recorder.

- You can also eject the cassette when the recorder is standby mode.

### Turn off the recorder

Press ⏻ on the remote

OR Press ⏻ on the recorder control.

## Playback Features

### Adjusting tracking condition

#### Automatic tracking adjustment

When a new cassette is loaded, the recorder enters the automatic tracking mode.

#### Manual tracking adjustment

If automatic tracking cannot eliminate noises well during playback, adjust the tracking manually.

Press and hold PR + or - to eliminate the noises.

### Selecting Soundtrack (HR-J695EA only)

Your recorder is capable of recording four soundtracks (STEREO, LEFT, RIGHT and MONO) and plays back the one you select. Set "AUDIO" to the appropriate mode. (ⓘ 4)

### Rewind Power Off

When the tape is not running, press ◀◀, then press ⏻. REW blanks on the screen. The recorder enters the standby mode automatically after rewinding the tape.

### Ez (Easy) Power Off

During playback, press ◀◀▲⏻. The recorder stops playback, rewinds the tape and ejects the cassette, then enters the standby mode automatically.

### Playing back selected scene repeatedly

#### — Ez (Easy) Repeat Playback

During playback, press and hold ⇐. The recorder starts the reverse search. Release this button at the point you want repeat playback to start. The recorder repeats the selected scene twice.

### Skipping unwanted portions

#### — Skip Search

Press 30 SEC ⏮ once to 6 times during playback. Each press initiates a 30-second period of high-speed playback (up to 3 minutes). When the specified portion of the tape is skipped, normal playback resumes automatically. To return to normal playback during Skip Search, press ►.

## Recording

### Accidental erasure prevention

To prevent accidental recording on a recorded cassette, remove its record safety tab. To record on it later, cover the hole with adhesive tape.



## Basic Recording

Turn on the TV and select the AV mode or video channel.

### 1 Load a cassette

Make sure the record safety tab is intact. If not, cover the hole with adhesive tape before inserting the cassette.

- The recorder turns on, and the counter is reset, automatically.

### 2 Select recording channel

Press **PR+/-** or the **number keys**.

- You can select channel in the stop mode or recording pause mode.

#### NOTE:

*The picture will be distorted when the channel is changed.*

### 3 Set tape speed

Press **SP/LP (//)**. The current setting for the tape speed appears on the screen for about 5 seconds. Press **SP/LP (//)** again to change the setting while tape speed is displayed.

### 4 Start recording

Press **●**.

- If the tape reaches its end during recording, the recorder stops recording, rewinds the tape and ejects the cassette, then enters the standby mode automatically.

## During recording

### Pause recording

Press **II**.

- Press **II** to resume recording.
- You can select channel in the recording pause mode.
- There will be a loss of color, or the picture will be distorted where the channel is changed.

### Stop recording

Press **■** on the remote **OR** Press **■/▲** on the recorder control.

## Recording Features

### Tape Position/Time Counter

Press **⓪ OK** repeatedly to display the tape position and time counter on the screen. To reset the time counter, press **0000**.

#### NOTE:

*Depending on the type of tape used, the tape position may not appear right away.*

## Memory Stop Facility

The recorder stops automatically when rewinding the tape and the counter reaches "0:00:00". If you set the counter to "0:00:00" before the playback or recording, you can easily access the pre-selected position by using the time counter.

- 1 Press **OK** repeatedly to display the counter on the screen.

- 2 Press **0000** to reset the counter before playback or recording.

- 3 Start playback or recording.

- 4 Press **◀◀** after playback or recording. The tape rewinds and stops automatically when the counter reaches to "0:00:00".

## Watching one programme while recording another

If your recorder is connected to the TV via the AV connection, press **TV/VCR**.

Once recording is in progress, all you need to do is to set the channel controls on the TV for the station you wish to view.

The programme selected with the TV's channel controls appears on the screen while the one selected with the **PR+/-** is recorded on the tape.

## Specifying recording length

### — Instant Timer Recording (ITR)

During recording, press **● (ITR)** repeatedly until the desired recording length appears on the screen.

- Each time you press the button, recording length increases in 30-minute intervals (up to 9 hours).
- The recorder enters the standby mode after recording is finished.
- To cancel an ITR, press **■** on the remote control or **■/▲** on the recorder.

## Receiving stereo and bilingual programmes (HR-J695EA only)

Your recorder is equipped with a Sound-Multiplex decoder (A2) and a Digital stereo sound decoder (NICAM) as well, making reception of stereo and bilingual broadcasts possible.

- To listen to a stereo programme, set "AUDIO" to "STEREO". (⓪ 4)
- To listen to a bilingual programme, set "AUDIO" to "LEFT" or "RIGHT". (⓪ 4)
- To listen to the standard (regular monaural) audio while receiving a NICAM broadcast, set "AUDIO" to "MONO". (⓪ 4)

### To record stereo and bilingual programmes (A2)

- Stereo programmes are automatically recorded in stereo on the Hi-Fi audio track (with the normal audio track recording mixed L and R channel sound).
- Bilingual programmes are automatically recorded in bilingual on the Hi-Fi audio track. The main soundtrack is recorded on the normal audio track.

### To record NICAM stereo and bilingual programmes

The NICAM audio programme is recorded on the Hi-Fi audio track, and the standard audio programme on the normal audio track.

#### NOTES:

- *If the quality of stereo sound being received is poor, the broadcast may be received in monaural with better quality.*
- *Before playing back a programme recorded in stereo, or a bilingual programme, set "AUDIO" to the appropriate mode.* (⓪ 4)

## Timer Recording

Up to 7 timer recording programmes within a month can be made.

### Before starting:

- Set the clock properly. (☞ 7)
- Set "SYSTEM" to the appropriate mode. (☞ 15)
- Load a cassette with the record safety tab intact.

### NOTES:

- Be sure to turn off the recorder before timer recording starts. Do not perform any operations during timer recording.
- If all the 7 programmes have already been set, "PROGRAM FULL" appears on the screen.
- If there is a conflict in the timer schedule and one programme overlaps with another, the programme starting earlier will be recorded. If the start times are the same, the programme made most recently will be recorded.
- If you wish to stop timer recording which has already started, press  $\psi/\lambda$ .
- After timer recording is completed, the recorder enters the standby mode automatically.
- If the tape reaches its end during timer recordings, the recorder stops recording, rewinds the tape and ejects the cassette, then enters the standby mode automatically.
- You can programme the timer recording while a regular recording is in progress; the menu screens will not be recorded.

## Timer Programming

**1** Press **MENU**. Press  $\triangleleft$  $\triangleright$  to select the icon "REC", then press **OK**. The programme list appears.

**2** Press **OK**.

**3** Press the appropriate **number keys** to set the channel, date, start time and stop time. Input "0" before any single number entries.

● To time-record daily (Monday–Friday) or weekly serials, press  $\triangleleft$  $\triangleright$  to select the "DATE" setting, then press **OK**. Press  $\triangleleft$  $\triangleright$ , then press **OK**.

● To set the tape speed (SP/LP/IP), press  $\triangleleft$  $\triangleright$  to select the tape speed, then press  $\triangleleft$  $\triangleright$ .

☞ "Intelligent LP Recording" on page 13.

**4** Press **MENU**. Press **MENU** again to return to normal screen.

**5** Press  $\psi/\lambda$ . The recorder enters timer standby mode. The timer indicator and standby/record indicator light on the display panel.

● If a cassette has not loaded when the recorder enters the timer standby mode, the timer indicator blinks on the display panel.

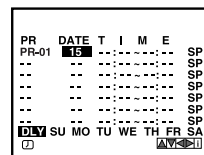
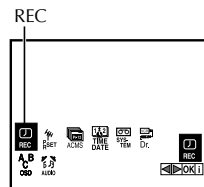

## Intelligent LP Recording

When you set the tape speed to "IP", the recorder automatically switches to LP mode to allow complete recording if there is not enough tape to record the entire programme while timer-recording in SP mode.

**For example**, recording a programme of 210 minutes in length onto a 180-minute tape.

Approximately 150 minutes      Approximately 60 minutes

SP mode	LP mode
Total 210 minutes	

### NOTES:

- If you have programmed the recorder to timer-record 2 or more programmes, do not use this function, but change the tape speed manually during timer programming.
- There may be some noise and sound disturbance where the tape speed switches from SP to LP mode on the tape.
- This function is not available during ITR (Instant Timer Recording), and will not work properly with any tapes longer than E-180 or with some tapes of shorter lengths.

## Checking, canceling or changing programme settings

### 1 Disengage timer recording standby mode

Press  $\psi/I$ .

### 2 Access Main Menu screen

Press **MENU**. Press  $\triangleleft/\triangleright$  to select the icon "REC", then press **OK**. The programme list appears.

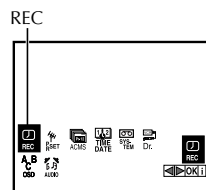

### 3 Cancel or change programme setting

**To cancel a programme**, press  $\triangle/\nabla$  to select the programme you want to delete, then press  $\triangleleft$ .

**To change a programme**, press  $\triangle/\nabla$  to select the programme, then press **OK**. Press  $\triangleleft/\triangleright$  to select the item you want to change, then press the **number keys** or  $\triangle/\nabla$  to change the settings. After confirming all information is correct, press **MENU**.

PR	DATE	T	I	M	E	LP
PR-01	15	13:00	-	14:00		LP
--	--	--	--	--	--	SP
--	--	--	--	--	--	SP
--	--	--	--	--	--	SP
--	--	--	--	--	--	SP

### 4 Return to normal screen

Press **MENU**.

### 5 Re-engage timer recording standby mode

Press  $\psi/I$ . The recorder enters timer standby mode. The timer indicator and standby/record indicator light on the display panel.

## Editing

### Editing with another video recorder or a camcorder

You can use your recorder as the source player or the recording deck. You can use a camcorder as the source player and your recorder as the recording deck. Refer also to the other components' instruction manuals for connection and its operations.

#### Connection with another video recorder

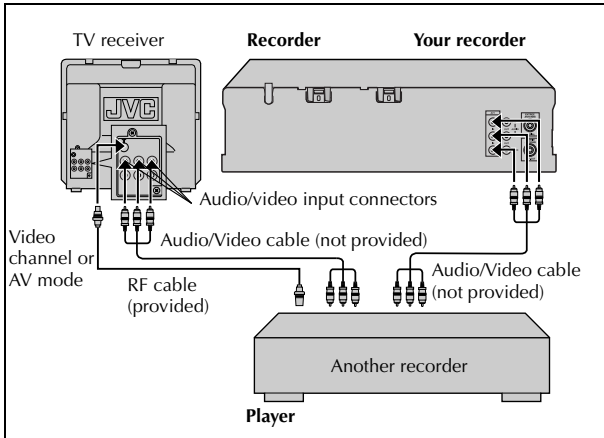

#### Connection with a camcorder

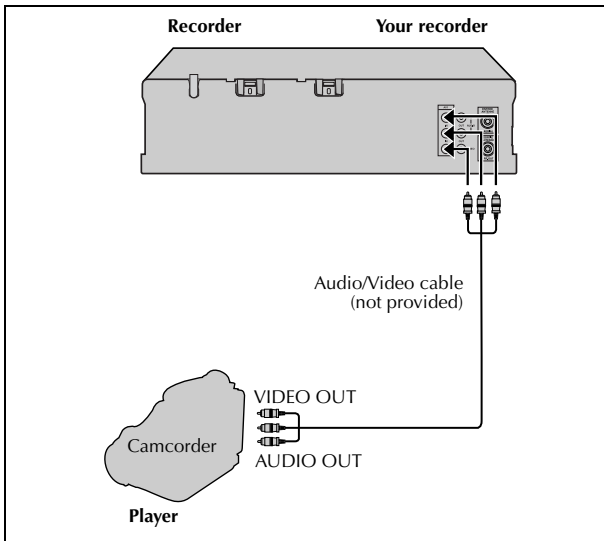

#### ATTENTION:

When you use this recorder as a source player, the indications of on-screen display or mode setting operations on the Main Menu screen are also recorded.

#### 1 Make connections

##### Connection with another video recorder

When you use this recorder as a source player, connect the recorder's AUDIO/VIDEO OUT connectors to the audio/video input connectors of another recorder.

When you use this recorder as a recorder, connect the recorder's AUDIO/VIDEO IN connectors to the audio/video output connectors of another recorder.

##### Connection with a camcorder

Connect the camcorder's AUDIO/VIDEO OUT connectors to the recorder's AUDIO/VIDEO IN connector.

- When using a monaural camcorder, connect its AUDIO OUT connector to the AUDIO L input connector on your recorder.

#### 2 Load cassettes

Insert the playback cassette into the source player and the cassette to be recorded on into the recording deck.

#### 3 Select input mode on recording deck

Select the correct external input on the recording deck. On this recorder, press **AV** and/or **PR+/-** to select "AV".

#### 4 Select edit mode

Select the appropriate edit mode for the components if such a mode is equipped.

#### 5 Start playback

Engage the Play mode of the source player.

#### 6 Start recording

Engage the Record mode of the recording deck.

## System Connections

### Connecting/Using a stereo system (HR-J695EA only)

You can listen to the soundtrack through your stereo system. Connect the AUDIO OUT L and R connectors on the recorder to the AUX IN or TAPE MONITOR connectors on your stereo system's receiver or amplifier.

- When listening to sound through the connected stereo system, turn the TV's volume down completely.

## Subsidiary Settings

### Recorder's Information (Self-Diagnosis)

This function allows you to check the status of the recorder and tape inserted into the recorder.

- 1 Press **MENU** to access Main Menu screen.
- 2 Press  $\triangleleft \triangleright$  to select the icon "VCR Dr.", then press **OK**.
- 3 Press  $\triangle \nabla$  to select item to check the status, then the status message appears on the screen. Refer to the table below.
- 4 Press **MENU** to return to normal screen.

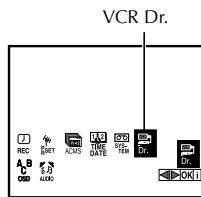

Item	Description/message
<b>HEAD STATUS</b>	You can check the status of the recorder's video head. OK: No problem PLEASE CLEAN: Clean the video heads using a dry cleaning cassette or be sure to contact your nearest JVC dealer.
<b>TAPE STATUS</b>	You can check the status of the tape inserted into the recorder. RECORDABLE: The cassette can be recorded. NOT RECORDABLE: Insert a cassette with the record safety tab intact, or cover the hole using adhesive tape.
<b>NO. OF TIMER PROGRAMME</b>	The number of timer programmes you made appears on the screen.
<b>NEXT TIMER PROGRAMME</b>	The detailed information of timer programme setting appears on the screen.

## Colour System Set

You can play back PAL, MESECAM and NTSC (3.58 or 4.43) tapes, or record PAL and MESECAM and NTSC (3.58 or 4.43) signals on this recorder. Select the appropriate colour system.

- 1 Press **MENU** to access Main Menu screen.
- 2 Press  $\triangleleft \triangleright$  to select the icon "SYSTEM", then press **OK**.
- 3 Press  $\triangle \nabla$  to select the appropriate mode, then press **OK**.
- 4 Press **MENU** to return to normal screen.

**AUTO:** Normally select this. The appropriate colour system is selected automatically depending on the playback or recording signals.

If "AUTO" does not work correctly, set the following mode manually.

**PAL:** To record PAL signals, or playback a PAL tape.

**MESECAM:** To record SECAM signals, or playback a MESECAM tape.

**NTSC PB:** To play back a NTSC tape on PAL TV.

**NTSC3.58:** To record NTSC3.58 signals, or playback a NTSC3.58 tape.

**NTSC4.43:** To record NTSC4.43 signals, or playback a NTSC4.43 tape.

You can change the system setting as follows:

Source	Mode	System change
PAL/ MESECAM	Playback	AUTO ↔ PAL ↔ MESECAM
	Recording	AUTO ↔ PAL ↔ MESECAM
NTSC	Playback	NTSC PB ↔ NTSC3.58 ↔ NTSC4.43
	Recording	NTSC3.58 ↔ NTSC4.43

### NOTES:

#### About NTSC Playback

- Some TVs shrink the picture vertically and place black bars at the top and bottom of the screen, or cut off the top and bottom portions of superimposed displays. This is not a malfunction.
- The picture may roll up and down. This can be corrected if your TV has the V-HOLD control function.
- The counter and tape remaining time readings will be incorrect.

#### HR-J695EA

- During search, still or frame-by-frame playback, the picture will be distorted, and there may be a loss of colour.

#### HR-J291EA

- During search or still playback, the picture will be distorted, and there may be a loss of colour.

## Child Lock

You can disable the recorder's operations. While the recorder is turned on, press  $\mathbb{A}$  on the remote control. "SAFE" appears on the screen.

To release the child lock, press  $\mathbb{A}$  until the power indicator blinks on the display panel.

- If any buttons on the recorder are pressed, "SAFE" appears on the screen and the power indicator blinks on the display panel.

### NOTES:

- When the child lock function is in use, keep the remote control out of the children's reach.
- Timer recording programs will be performed even if the child lock function activated.

# Specifications

## GENERAL

Power	: 110 V – 240 V~, 50 Hz/60 Hz
Power consumption	
Power on	: Approx. 12 W
Standby mode	: 3.0 W
Video Head system	
HR-J695EA	: DA4 (Double Azimuth) head helical scan system
HR-J291EA	: Rotary two-head helical scan system
Tape speed	
(SP)	: 23.39 mm/sec
(LP)	: 11.69 mm/sec
Tape format	: Tape width 1/2" (12.7 mm high density VHS tape)
Maximum recording time	
(SP)	: 240 min. with E-240 video cassette
(LP)	: 480 min. with E-240 video cassette
Rewind time	: Approx. 180 (±30) sec. with E-180 cassette
Dimensions (W x H x D)	: 360 mm x 94.5 mm x 270 mm
Weight	: 4.0 kg
Operating temperature	: 5°C to 35°C
Operating humidity	: Less than 80 %
Timer	: 24 hours display type

## VIDEO

Signal system	: PAL-type colour signal and CCIR monochrome signal, 625 lines 50 fields
Recording Format	: PAL/MESECAM/NTSC 3.58/NTSC 4.43
RF reception	
HR-J695EA	: PAL B/G, SECAM D/K
HR-J291EA	: PAL B/G
RF OUT	: PAL B/G
RF modulator	: UHF channels 22 – 68 (Adjustable)
Input level	: VIDEO IN (RCA type) 1.0 Vp-p, 75 $\Omega$ , unbalanced
Output level	: VIDEO OUT (RCA type) 1.0 Vp-p, 75 $\Omega$ , unbalanced
Signal-to-noise ratio	: More than 43 dBm

## AUDIO

Input level	: AUDIO IN (RCA type) –6.0 dBm, more than 47 k $\Omega$
Output level	: AUDIO OUT (RCA type) –6.0 dBm, less than 1 k $\Omega$
Audio track	
HR-J695EA	: Mono track and Hi-Fi track
HR-J291EA	: Mono track
Audio frequency response	
Normal audio	: 100 Hz to 10,000 Hz (–6/+3 dBm)
Hi-Fi audio*	: 20 Hz to 20,000 Hz (–3/+3 dBm)
* HR-J695EA only	
Audio signal to noise ratio	
Normal audio	: More than 43 dB (JIS A filter)
Hi-Fi audio*	: More than 70 dB (JIS A filter)
* HR-J695EA only	
Audio dynamic range [HR-J695EA only]	
Hi-Fi audio	: More than 85 dB (JIS A filter)

## ACCESSORIES

Provided accessories	: RF cable, Infrared remote control unit, "R3" battery x 2
----------------------	------------------------------------------------------------

Specifications shown are for SP mode unless specified otherwise. E. & O.E. Design and specifications subject to change without notice.